



Vis autoperceuse, tête fraisée

INDEX

DIN-7504-P HP Z

Zinguée. Empreinte PH

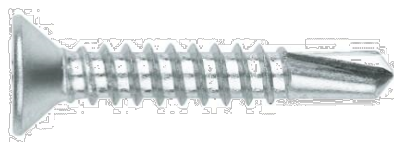

Matériaux utilisés:

MÉTAL





Tôle -
profilé lourd

Tôle

Matériau du produit / Revêtement:

Zingué

BOÎTE PROFESSIONNELLE

CODE	MESURES			EAN	PRIX
ABP3509	3,5 x 9,5	1000 pcs.	24000 pcs.	8423533129406	1,713
ABP3511	3,5 x 11	1000 pcs.	24000 pcs.	8423533129505	1,7
ABP3513	3,5 x 13	1000 pcs.	24000 pcs.	8423533129604	1,869
ABP3516	3,5 x 16	1000 pcs.	24000 pcs.	8423533129703	1,966
ABP3519	3,5 x 19	1000 pcs.	12000 pcs.	8423533129802	2,175
ABP3522	3,5 x 22	1000 pcs.	12000 pcs.	8423533129901	2,688
ABP3525	3,5 x 25	500 pcs.	12000 pcs.	8423533130068	3,119
ABP3913	3,9 x 13	1000 pcs.	24000 pcs.	8423533130105	2,219
ABP3916	3,9 x 16	1000 pcs.	12000 pcs.	8423533130204	2,431
ABP3919	3,9 x 19	1000 pcs.	12000 pcs.	8423533130303	2,647
ABP3922	3,9 x 22	500 pcs.	12000 pcs.	8423533128171	2,881
ABP3925	3,9 x 25	500 pcs.	12000 pcs.	8423533130242	3,094
ABP3932	3,9 x 32	500 pcs.	6000 pcs.	8423533127563	3,547
ABP3938	3,9 x 38	500 pcs.	6000 pcs.	8423533129468	3,7
ABP4213	4,2 x 13	1000 pcs.	12000 pcs.	8423533130808	2,278
ABP4216	4,2 x 16	1000 pcs.	12000 pcs.	8423533130907	2,881
ABP4219	4,2 x 19	1000 pcs.	12000 pcs.	8423533131003	2,966
ABP4222	4,2 x 22	500 pcs.	12000 pcs.	8423533127273	3,547
ABP4225	4,2 x 25	500 pcs.	6000 pcs.	8423533190659	3,763
ABP4232	4,2 x 32	500 pcs.	6000 pcs.	8423533191557	4,428
ABP4238	4,2 x 38	500 pcs.	6000 pcs.	8423533128089	5,934
ABP4813	4,8 x 13	1000 pcs.	12000 pcs.	8423533131508	3,547
ABP4816	4,8 x 16	1000 pcs.	12000 pcs.	8423533131607	3,763
ABP4819	4,8 x 19	1000 pcs.	8000 pcs.	8423533131706	3,975
ABP4825	4,8 x 25	500 pcs.	6000 pcs.	8423533189950	4,644
ABP4832	4,8 x 32	500 pcs.	6000 pcs.	8423533190758	5,309
ABP4838	4,8 x 38	500 pcs.	3000 pcs.	8423533128843	6,191
ABP4850	4,8 x 50	500 pcs.	3000 pcs.	8423533128072	8,188
ABP5519	5,5 x 19	500 pcs.	6000 pcs.	8423533128942	6,513
ABP5525	5,5 x 25	500 pcs.	6000 pcs.	8423533129642	6,641
ABP5532	5,5 x 32	500 pcs.	3000 pcs.	8423533129567	8,425
ABP5538	5,5 x 38	500 pcs.	3000 pcs.	8423533126542	9,072
ABP5550	5,5 x 50	500 pcs.	3000 pcs.	8423533127969	10,381

BLISTER



CODE	MESURES	QUANTITÉ	SACS	EAN	QUANTITÉ	EAN	PRIX
BZABP3513	3,5 x 13	800 pcs.	20 sacs	8423533430939	40pcs.	8423533423283	2,58
BZABP3516	3,5 x 16	800 pcs.	20 sacs	8423533430946	40pcs.	8423533423290	2,58
BZABP4219	4,2 x 19	800 pcs.	20 sacs	8423533430953	40pcs.	8423533423306	2,58
BZABP4225	4,2 x 25	400 pcs.	20 sacs	8423533430960	20pcs.	8423533423313	2,58
BZABP4232	4,2 x 32	400 pcs.	20 sacs	8423533430977	20pcs.	8423533423320	2,58

BOÎTE À FENÊTRE



CODE	MESURES	QUANTITÉ	SACS	EAN	QUANTITÉ	EAN	PRIX
VABP3513	3,5 x 13	2000 pcs.	8 sacs	8423533401793	250pcs.	8423533756572	5,768
VABP3516	3,5 x 16	1800 pcs.	8 sacs	8423533401809	225pcs.	8423533756589	5,735
VABP3519	3,5 x 19	1600 pcs.	8 sacs	8423533401816	200pcs.	8423533756596	5,995
VABP3525	3,5 x 25	1440 pcs.	8 sacs	8423533401823	180pcs.	8423533756602	6,191
VABP3913	3,9 x 13	1600 pcs.	8 sacs	8423533411174	200pcs.	8423533774583	5,321
VABP3916	3,9 x 16	1600 pcs.	8 sacs	8423533411181	200pcs.	8423533774590	5,833
VABP3919	3,9 x 19	1400 pcs.	8 sacs	8423533411198	175pcs.	8423533774606	5,802
VABP3925	3,9 x 25	1200 pcs.	8 sacs	8423533411204	150pcs.	8423533774613	5,652
VABP3938	3,9 x 38	800 pcs.	8 sacs	8423533411211	100pcs.	8423533774620	5,307
VABP4213	4,2 x 13	1400 pcs.	8 sacs	8423533411228	175pcs.	8423533774637	5,104
VABP4216	4,2 x 16	1400 pcs.	8 sacs	8423533411235	175pcs.	8423533774644	5,802
VABP4219	4,2 x 19	1400 pcs.	8 sacs	8423533401830	175pcs.	8423533756619	6,28
VABP4225	4,2 x 25	1000 pcs.	8 sacs	8423533401847	125pcs.	8423533756626	5,662
VABP4232	4,2 x 32	720 pcs.	8 sacs	8423533401854	90pcs.	8423533756633	4,778
VABP4238	4,2 x 38	600 pcs.	8 sacs	8423533401861	75pcs.	8423533756640	4,648
VABP4816	4,8 x 16	1000 pcs.	8 sacs	8423533411242	125pcs.	8423533774651	5,558
VABP4819	4,8 x 19	800 pcs.	8 sacs	8423533411259	100pcs.	8423533774668	4,699
VABP4825	4,8 x 25	720 pcs.	8 sacs	8423533401878	90pcs.	8423533756657	4,808
VABP4832	4,8 x 32	600 pcs.	8 sacs	8423533401885	75pcs.	8423533756664	5,339
VABP4838	4,8 x 38	600 pcs.	8 sacs	8423533405807	75pcs.	8423533766908	6,231
VABP5532	5,5 x 32	400 pcs.	8 sacs	8423533401892	50pcs.	8423533756671	4,803

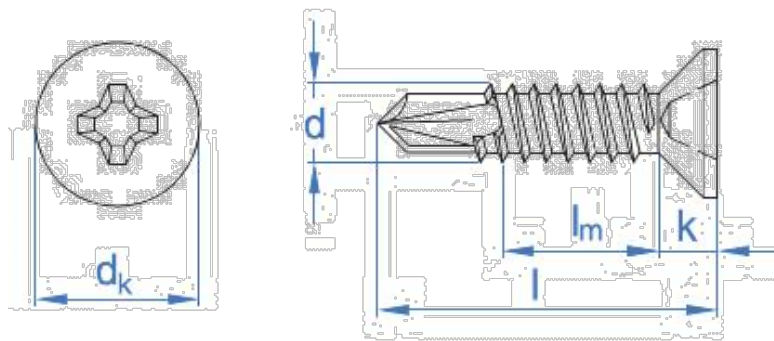

CODE	MESURES	Épaisseur max. à fixer
ABP3509	3,5 x 9,5	2,85
ABP3511	3,5 x 11	4,2
ABP3513	3,5 x 13	6,2
ABP3516	3,5 x 16	9,2
ABP3519	3,5 x 19	12,1
ABP3522	3,5 x 22	15,1
ABP3525	3,5 x 25	18,1
ABP3913	3,9 x 13	5,8
ABP3916	3,9 x 16	8,8
ABP3919	3,9 x 19	11,7
ABP3922	3,9 x 22	14,7
ABP3925	3,9 x 25	17,7
ABP3932	3,9 x 32	24,5
ABP3938	3,9 x 38	30,5
ABP4213	4,2 x 13	4,3
ABP4216	4,2 x 16	7,3
ABP4219	4,2 x 19	10,3
ABP4222	4,2 x 22	13,3
ABP4225	4,2 x 25	16,3
ABP4232	4,2 x 32	23
ABP4238	4,2 x 38	29
ABP4813	4,8 x 13	3,7
ABP4816	4,8 x 16	5,5
ABP4819	4,8 x 19	8,7
ABP4825	4,8 x 25	14,7
ABP4832	4,8 x 32	21,5
ABP4838	4,8 x 38	27,5
ABP4850	4,8 x 50	39,5

ABP5519	5,5 x 19	8,7
ABP5525	5,5 x 25	14,7
ABP5532	5,5 x 32	21,5
ABP5538	5,5 x 38	27,5
ABP5550	5,5 x 50	39,5
BZABP3513	3,5 x 13	6,2
BZABP3516	3,5 x 16	9,2
BZABP4219	4,2 x 19	10,3
BZABP4225	4,2 x 25	16,3
BZABP4232	4,2 x 32	23
VABP3513	3,5 x 13	6,2
VABP3516	3,5 x 16	9,2
VABP3519	3,5 x 19	12,1
VABP3525	3,5 x 25	18,1
VABP3913	3,9 x 13	5,8
VABP3916	3,9 x 16	8,8
VABP3919	3,9 x 19	11,7
VABP3925	3,9 x 25	17,7
VABP3938	3,9 x 38	30,5
VABP4213	4,2 x 13	4,3
VABP4216	4,2 x 16	7,3
VABP4219	4,2 x 19	10,3
VABP4225	4,2 x 25	16,3
VABP4232	4,2 x 32	23
VABP4238	4,2 x 38	29
VABP4816	4,8 x 16	5,5
VABP4819	4,8 x 19	8,7
VABP4825	4,8 x 25	14,7
VABP4832	4,8 x 32	21,5
VABP4838	4,8 x 38	27,5
VABP5532	5,5 x 32	21,5

CARACTÉRISTIQUES



Zingué



Ph

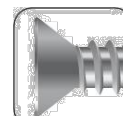

Fraisée

RECOMMANDÉ POUR

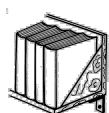

Fixation étagère



Fixation extincteur



Affichage en Centre Commercial

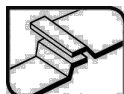

Profilés tôles



Panneaux sandwich sur auvent



Enseigne



Toiture en tôle

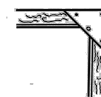

Vis platine



FICHE TECHNIQUE

<https://www.indexfix.com/docs/ft-bro-fr.pdf>

*Les données présentées dans ce tableau sont pour information seulement et ne constituent en aucun cas, les conditions contractuelles d'approvisionnement. Les références à notre catalogue seront disponibles jusqu'à épuisement des stocks.

Nos tarifs n'incluent pas les taxes indirectes sur la valeur ajoutée. Ils seront taxés conformément aux normes en vigueur dans les transactions nationales et internationales.