



DIN-7504-K A2

Vis. Inoxydable A2

Matériaux utilisés:

INOXYDABLE

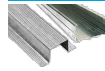

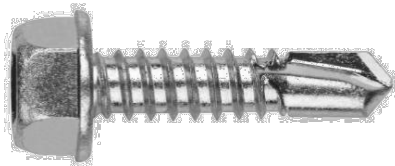

Profilé en aluminium



Matériau du produit / Revêtement:

Inoxydable A2

BOÎTE PROFESSIONNELLE

CODE	MESURES			EAN	RIX
ABEI4213	4,2 x 13	1000 pcs.	12000 pcs.	8423533814364	19,538
ABEI4216	4,2 x 16	1000 pcs.	8000 pcs.	8423533814371	21,922
ABEI4219	4,2 x 19	1000 pcs.	8000 pcs.	8423533814388	22,713
ABEI4813	4,8 x 13	1000 pcs.	8000 pcs.	8423533814395	27,638
ABEI4816	4,8 x 16	500 pcs.	6000 pcs.	8423533447388	27,003
ABEI4819	4,8 x 19	500 pcs.	6000 pcs.	8423533808929	29,225
ABEI4825	4,8 x 25	500 pcs.	6000 pcs.	8423533814401	32,719
ABEI4832	4,8 x 32	500 pcs.	3000 pcs.	8423533814418	38,913
ABEI5519	5,5 x 19	500 pcs.	6000 pcs.	8423533814425	40,341
ABEI5522	5,5 x 22	500 pcs.	4000 pcs.	8423533814432	43,044
ABEI5525	5,5 x 25	500 pcs.	6000 pcs.	8423533814449	45,744
ABEI6319	6,3 x 19	500 pcs.	3000 pcs.	8423533814456	61,153
ABEI6325	6,3 x 25	500 pcs.	3000 pcs.	8423533805393	69,566

INFORMATION TECHNIQUE

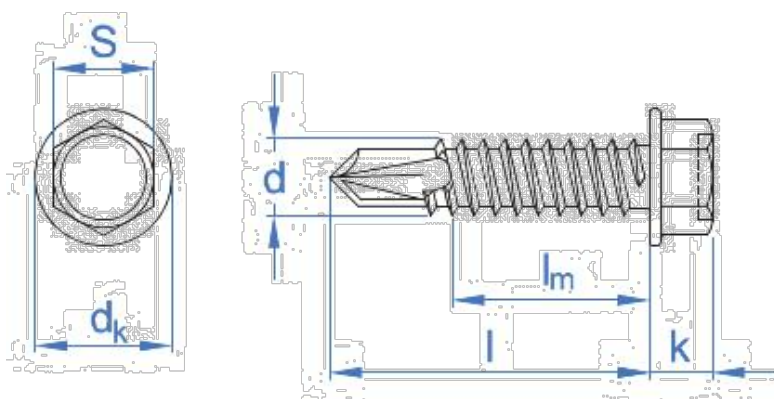

CODE	MESURES	Épaisseur max. à fixer		Clé d'installation
ABEI4213	4,2 x 13	4,3	7	
ABEI4216	4,2 x 16	7,3	7	
ABEI4219	4,2 x 19	10,3	7	
ABEI4813	4,8 x 13	3,7	8	
ABEI4816	4,8 x 16	5,5	8	
ABEI4819	4,8 x 19	8,7	8	
ABEI4825	4,8 x 25	14,7	8	
ABEI4832	4,8 x 32	21,5	8	
ABEI5519	5,5 x 19	8,7	8	
ABEI5522	5,5 x 22	11,7	8	
ABEI5525	5,5 x 25	14,7	8	
ABEI6319	6,3 x 19	7	10	
ABEI6325	6,3 x 25	13	10	

CARACTÉRISTIQUES



Inoxydable A2

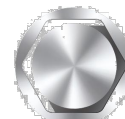

Hesagonale avec rondelle

RECOMMANDÉ POUR



Fixation étagère



Fixation extincteur



Affichage en Centre Commercial

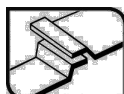

Profilés tôles



Panneaux sandwich sur auvent



Enseigne

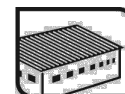

Toiture en tôle

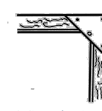

Vis platine



FICHE TECHNIQUE

<https://www.indexfix.com/docs/ft-brocu-fr.pdf>

*Les données présentées dans ce tableau sont pour information seulement et ne constituent en aucun cas, les conditions contractuelles d'approvisionnement. Les références à notre catalogue seront disponibles jusqu'à épuisement des stocks.

Nos tarifs n'incluent pas les taxes indirectes sur la valeur ajoutée. Ils seront taxés conformément aux normes en vigueur dans les transactions nationales et internationales.